

PANORAMIC RANGE



PUSHBUTTONS	1 pole		2 pole	3 pole	4 pole
	Ø12	Ø14	Ø14		
					
Waterproof front face	Y/N		Y/N	N	N
Function	NO, NC or NO/NC		2 x NO/NC	3 x NO/NC	4 x NO/NC
Button	Ø4, Ø5, Ø7, Ø9.4 short or round or rectangular		Ø5, Ø9.4 or rectangular	Ø9	Ø8
Color	Black/Red/Grey/White/Blue		Black/Red/Grey/White/Blue	Black	Red
Terminal	Silver or Gold		Silver or Gold	Gold	Gold
Accessories	Monostable flap Bistable flap Bistable flap with auxiliary contact Electroluminescent ring		Monostable flap Bistable flap Bistable flap with auxiliary contact Electroluminescent ring	Monostable flap Bistable flap Bistable flap with auxiliary contact	Monostable flap Bistable flap Bistable flap with auxiliary contact

THUMBSTICK	Analogue	Analogue + validation
	Ø14	Ø24
		
Waterproof front face	Y	Y
Function	0 → 15 V	0 → 15 V
Button	Convex	Convex
Color	Black	Black
Terminal	Solder	Solder

MULTIWAY	2-way		2-way + validation	4-way	4-way double pole	4-way + validation
	Ø16	Ø18	Ø24	Ø16	Ø24	Ø24
						
Waterproof front face	Y/N	N	Y	Y/N	Y	Y
Function	NO	NO	NO	NO	NO	NO, NO/NC
Button	Rectangular, Concave, Convex	Convex	Cone, Concave, Convex, Castle	Concave, Cone, Convex, Long bat, Medium bat, short bat	Cone	Cone, Concave, Chinese, Castle
Color	Black	Black	Black	Black	Black/Grey	Black
Terminal	Silver or Gold	Silver or Gold	Silver or Gold	Silver, Gold or Tined	Silver	Silver or Gold

TRIGGER	1 position	2 positions
		
Waterproof front face	Y/N	Y/N
Function	NO, NC or NO/NC	2 x NO/NC or 4 x NO/NC
Color	Red/Black/Grey	Red/Black/Grey
Terminal	Silver or Gold	Silver or Gold

TRIM SWITCH	2-way		2-way + validation	4-way + validation
	Ø24	Customized	Ø24	Ø24
				
Waterproof front face	N		N	N
Function	2 x NO/NC + 2 x NO/NC		2 x NO + NO	4 x NO + NO
Button	Chinese	Pyramidal	Round	Round
Color	Black		Black	Black
Terminal	Gold		Silver	Silver

ROCKER	3 positions	3 positions	5 positions
			
Waterproof front face	N		
Function	1x NO/NC + 1x NO/NC	2x NO/NC + 2x NO/NC	1x NO/NC + 1x NO/NC + 1x NO/NC + 1x NO/NC
Button	Rectangular	Gendarme	Rectangular
Color	Black		
Terminal	Silver		

TOGGLE (CONSULT US)	2 positions		3 positions	
	Ø6	Ø12	Ø6	Ø12
				
Waterproof front face	N			
Function	1x NO + 1x NC	2 x NO + 2 x NC	2 x NO + 2 x NC	2 x NO + 2 x NC
Color	Black/Chrome	Black/Chrome	Chrome	Black/Chrome
Terminal	Silver	Gold	Silver	Silver or Gold
Accessories	Grey cap			

BUTTON PROTECTION			
Circular	Metallic flap guard	Plastic flap guard	Plastic flap guard with auxiliary contacts
			

PUSHBUTTONS 1 POLE

Ø 12	1 pole Double-throw	Color	Electrical configuration	Ø 4	Ø 7	Ø 7 + bezel	Ø 7 + bayonet	QuickFix®
	No seal	black	NO	♦	83450701	83450712	83450738	♦
			NO/NC	83450714	83450702	83450717 83450718 83450720 83450728	♦	♦
		red	NO	♦	83450704	♦	♦	♦
			NO/NC	♦	83450703	83450719	♦	♦
		grey	NO	♦		83450711	♦	♦
		Front face seal	black	NO/NC	83450724	83450713 83450716 83450715 83450732	83450723	♦
	red		NO/NC	♦	83450708	83450722	♦	♦
	grey		NO/NC	♦	83450707	83450721	♦	♦
	blue		NO/NC	♦	83450729	♦	♦	♦

CONTACT US FOR ANY MISSING REFERENCE

Low level - Gold plated

	1 pole	
	No seal	Front face seal
Mechanical characteristics		
Operating force	8 N → 16 N max	8 N → 16 N max
Release force	3 N min	3 N min
Permissible force at end of travel	100 N	100 N
Overtravel	0.4 mm min	0.4 mm min
Total travel	2 mm ± 0.4	2 mm ± 0.4
Return overtravel	0.4 min	0.4 min
Mechanical life	300 000 cycles	100 000 cycles
Electrical characteristics		
Voltage	5 VCC to 115 VAC 400 Hz	5 VCC to 115 VAC 400 Hz
Current (resistive load)	0.1 mA to 7.5 A	0.1 mA to 7.5 A
Current (inductive load)	2 A	2 A
Contact resistance	25 mOhm	25 mOhm
Electrical life	100 000 cycles	100 000 cycles
Dielectric strength	1 200 V	1 200 V
General characteristics		
Case	polyamid 6.6 reinforced with 30% fiberglass	polyamid 6.6 reinforced with 30% fiberglass
Button	acetate resin	acetate resin
Terminal	Soldering lugs W2 silver or gold plated	Soldering lugs W2 silver or gold plated
Waterproof front face	-	MIL STD 810 D-506.2 methode 2
Operating temperature	-55°C → +85°C	-55°C → +85°C
Storage temperature	-55°C → +85°C	-55°C → +85°C
Weight	3.6g ±5% < M < 7.6g ±5%	3.6g ±5% < M < 7.6g ±5%

Ø 14	1 pole Double-throw	Color	Electrical configuration	Ø 5	Ø 5 + guard	Ø 9.4	Ø 9.4 short hat	Ø 9.4 short hat + guard	Ø 9.4 round	Ø 9.4 1/4 turn fixation (or bayonet)	Ø 9.4 long travel	concave	QuickFix®	
	No seal	black	NO/NC	83450501	♦	83450001	♦	83450014	83450025	83450019 83450026 83450030 83450035 83450032	83451001	83450506	83450401 83450402 83450403	
			NO/NC	83450502	83450511	83450002	83450008	♦	♦	83450029	♦	♦	83450404	
		grey	NO/NC	♦	♦	♦	83450017	♦	♦	♦	♦	♦	♦	
			NO/NC	♦	♦	♦	♦	♦	♦	♦	♦	♦	♦	
		Front face seal	black	NO/NC	83450512	♦	83450006 83450028	83450012	♦	83450013	♦	83451003 83451004	83450513	♦
			red	NO/NC	83450510	♦	83450007	83450011	♦	♦	♦	♦	♦	♦
	grey		NO/NC	83450509	♦	83450005 83450015	83450010	83450009 83450018	♦	♦	♦	♦	♦	
	blue		NO/NC	83450514	♦	83450016	83450036	♦	♦	♦	♦	♦	♦	

CONTACT US FOR ANY MISSING REFERENCE

Low level - Gold plated

Electrical diagram

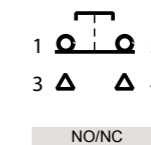
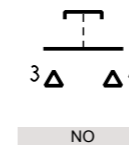

Dimensions

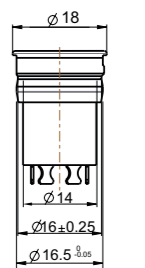
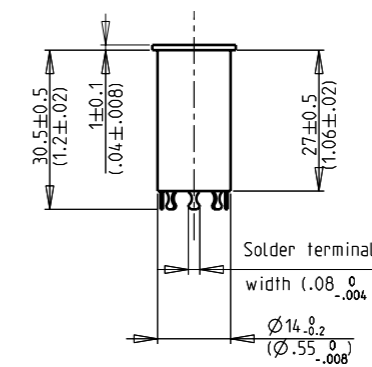
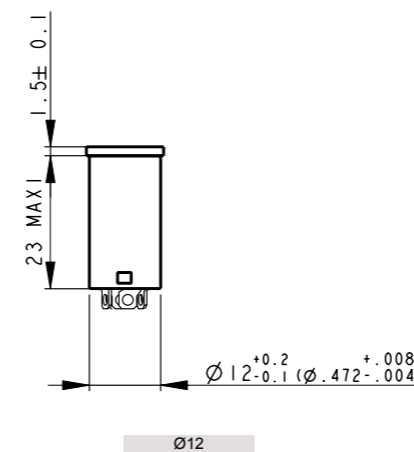

PUSHBUTTONS 2, 3 & 4 POLE

	Color	Electrical Configuration	Ø 5	Ø 5 +guard	Ø 5 high strength	Ø 8	Ø 9.4	Ø 9.4 higher strength	Ø 9.4 short hat	Ø 9.4 short hat+ higher strength	Ø 9.4 short hat+guard	Ø 9.4 short hat+guard + higher strength	Ø 9.4 round	Ø 9.4 luminescent ring	Ø 9.4 screw fixation	Ø 9.4 +wires	Ø 9.4 1/4 turn fixation (or bayonet)	Ø 9.4 long travel	Ø 12 concave	rectangular	rectangular high strength	QuickFix®			
Ø 14	No seal	black	2 x NO/NC	83453501	♦	♦	♦	83453001	♦	83453005	♦	83453006	♦	♦	♦	♦	♦	♦	83453026	♦	♦	83453506	♦		
		red	2 x NO/NC	83453502	♦	♦	♦	83453002	♦	83453015	♦	♦	♦	♦	♦	83453040	83453019	♦	♦	♦	♦	♦	♦	♦	
		white	2 x NO/NC	83453516	♦	♦	♦	♦	♦	83453025	♦	♦	♦	♦	♦	♦	♦	♦	♦	♦	♦	♦	♦	♦	
		grey	2 x NO/NC	♦	♦	♦	♦	83453018	♦	♦	♦	♦	♦	♦	♦	♦	♦	♦	♦	♦	♦	♦	♦	♦	
		Front face seal	black	2 x NO/NC	83453511 83453517	♦ 83453509 83453518	83453510	♦	83453012 83453020	83453039	83453013 83453032	♦	83453017 83453045	83453029	83453031 83453034	♦	♦	♦	♦	♦	83453014	83453514	♦	♦	♦
			red	2 x NO/NC	83453508	83453512	♦	♦	83453010 83453036	83453022	83453033	83453024	83453011	83453023	83453021	83453027	♦	♦	83453035	♦	♦	♦	♦	♦	83453311
	grey		2 x NO/NC	83453507	♦	♦	♦	83453008	♦	♦	♦	83453009	♦	♦	♦	♦	♦	♦	♦	♦	♦	♦	♦	83453310	
	blue		2 x NO/NC	♦	♦	♦	♦	♦	♦	♦	♦	♦	♦	♦	♦	♦	♦	83453030	♦	♦	♦	♦	♦	♦	
	3 pole	No seal	black	3 x NO/NC			♦	83460115																	
	4 pole	No seal	red	4 x NO/NC			♦																		

CONTACT US FOR ANY MISSING REFERENCE

Low level - Gold plated

	2 pole		3 pole	4 pole
	No seal	Front face seal	No seal	No seal
Mechanical characteristics				
Operating force	8 N → 16 N max		6.7 N max	1 N max
Release force	3 N min		3 N min	1.1 N min
Permissible force at end of travel	100 N		100 N	100 N
Overtravel	0.4 mm min		-	-
Total travel	2 mm ± 0.4		-	-
Return overtravel	0.4 mm min		-	-
Mechanical life	300 000 cycles		600 000 cycles	100 000 cycles
Electrical characteristics				
Voltage	5 VCC to 115 VAC 400 Hz		14 VDC to 28 VDC	14 VDC to 28 VDC
Current (resistive load)	0.1 mA to 7.5 A		3 mA to 5 A	1 mA to 1 A
Current (inductive load)	2 A		3 A	2 A
Contact resistance	25 mOhm		25 mOhm	25 mOhm
Electrical life	100 000 cycles		50 000 cycles	100 000 cycles
Dielectric strength	1 200 V		1 200 V	1 200 V
General characteristics				
Case	polyamid 6.6 reinforced with 30% fiberglass		diallyl	diallyl
Button	acetate resin		acetate resin	acetate resin
Terminal	Soldering lugs W2 silver or gold plated		Soldering terminal brass, gold plated	Soldering terminal brass, gold plated
Waterproof front face	-		MIL STD 810 D-506.2 methode 2	-
Operating temperature	-55°C → +85°C		-40°C → +70°C	-40°C → +70°C
Storage temperature	-55°C → +85°C		-55°C → +85°C	-55°C → +85°C
Weight	3.6g ±5% < M < 7.7g ±5%		20g	20g

Electrical diagram

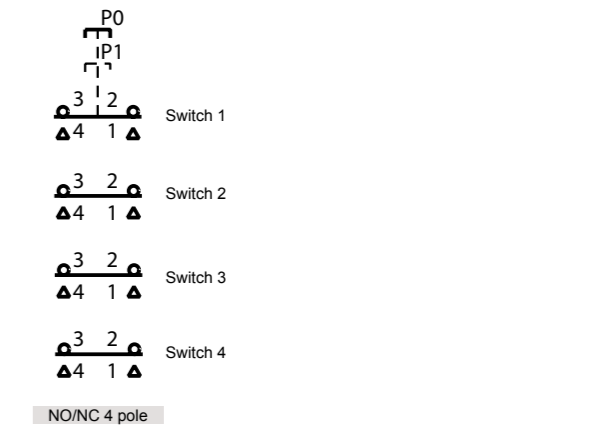
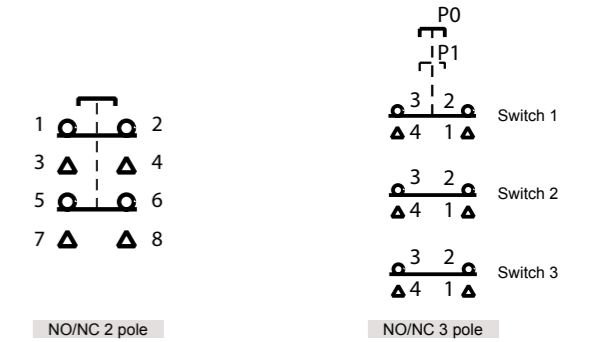

Dimensions

